

...wedi®

Fundo Riolito neo, Riolito, Riofino

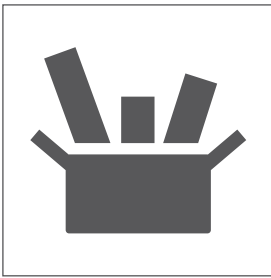



 0799 (System 2+)
wedi GmbH Hollefeldstraße 51 48282 Emsdetten 13 0799-CPR-132 DoP 0001
ETA-13/0385 ETAG 022 Teil 3
Bausatz mit wasserdichten Platten und weiteren Komponenten zur Herstellung einer Abdichtung unter einer Nuttschicht für die Verwendung in innen liegenden Nassbereichen Klassifizierung des Systems und deklarierte Produkt- und Systemeigenschaften siehe Anhang 1 der ETA-13/0385

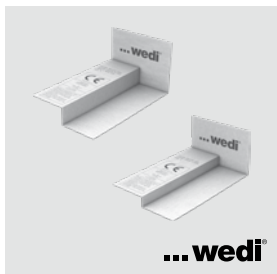
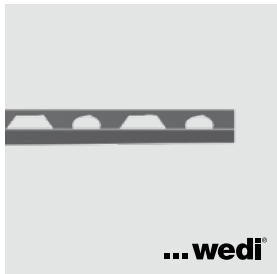
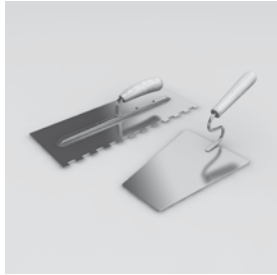
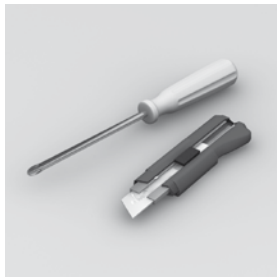
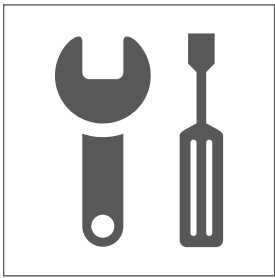

Fundo Riolito neo

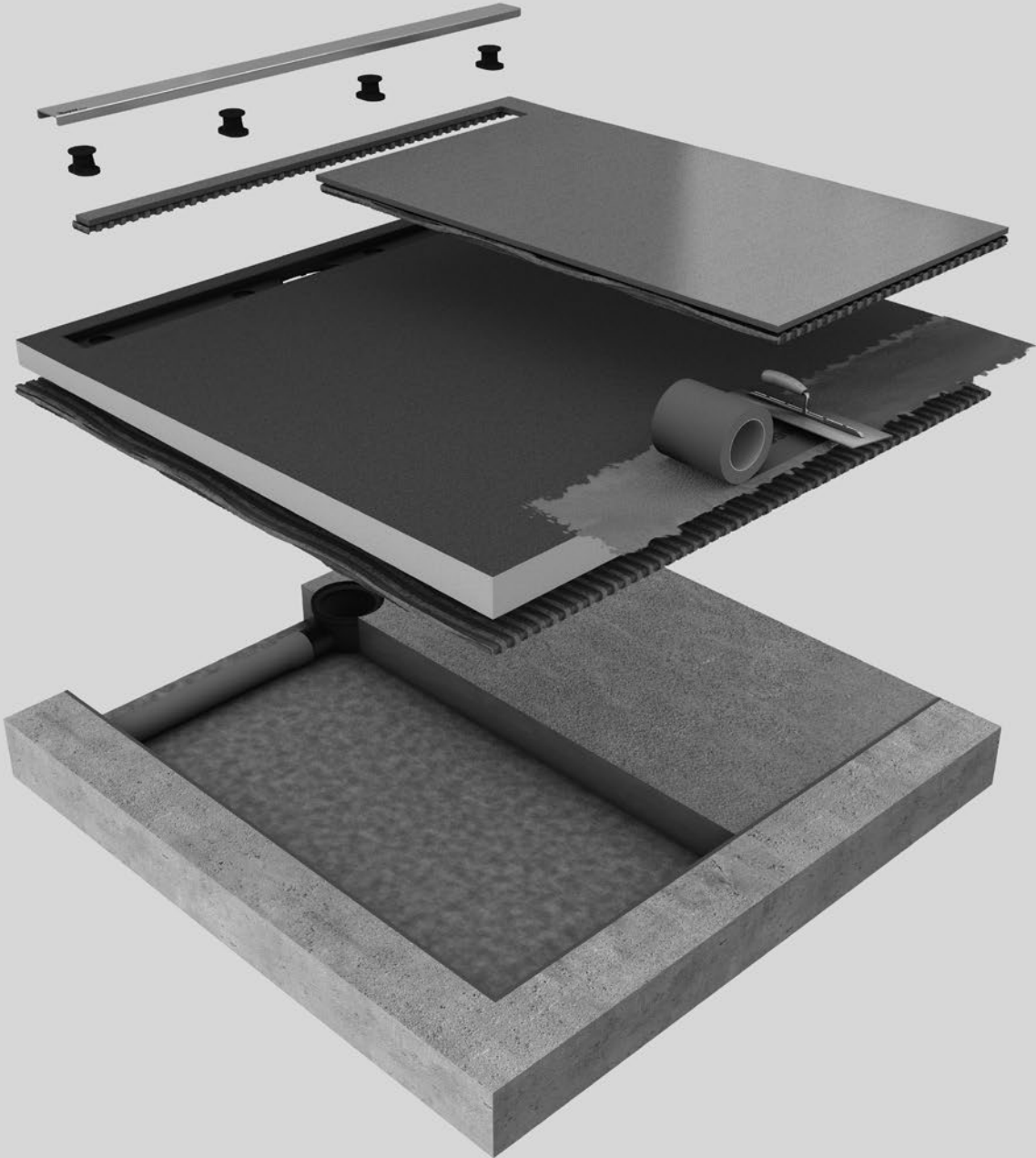

Fundo Riolito

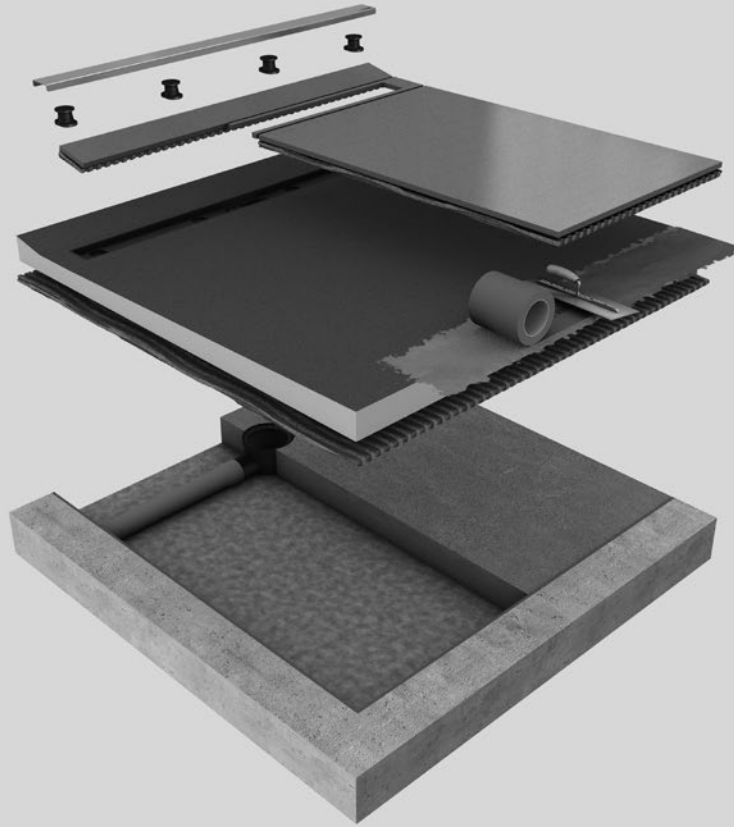

Fundo Riofino

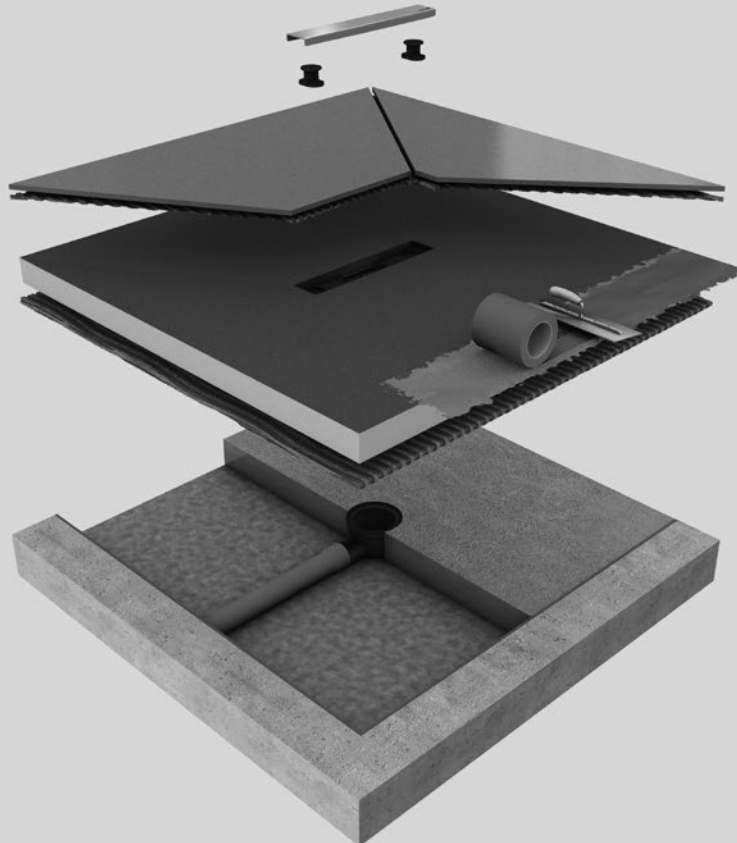

Fundo Riolito neo

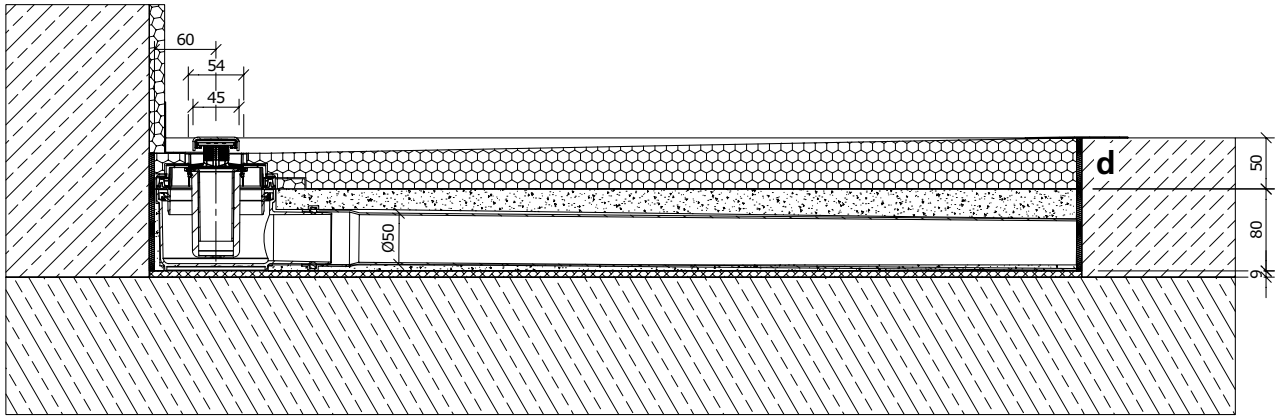

Fundo Riolito

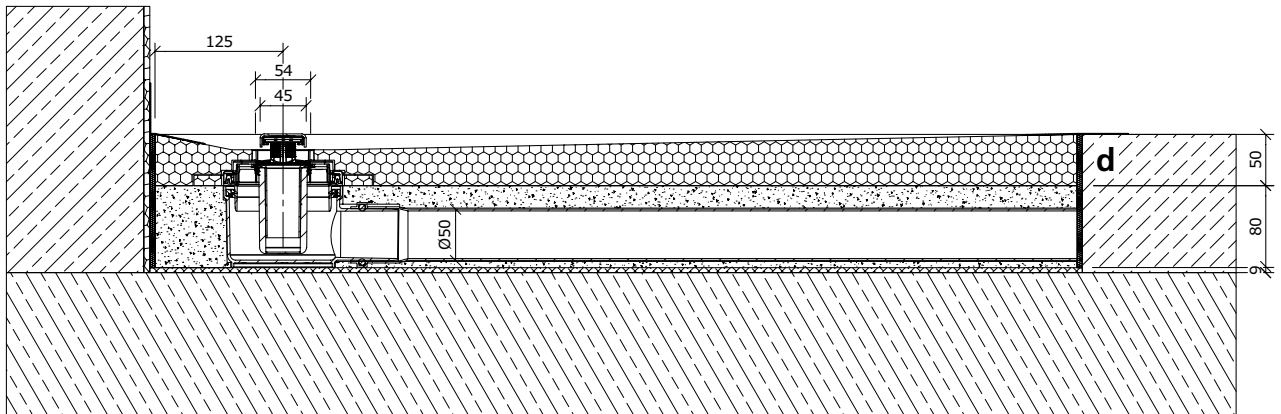

Fundo Riofino

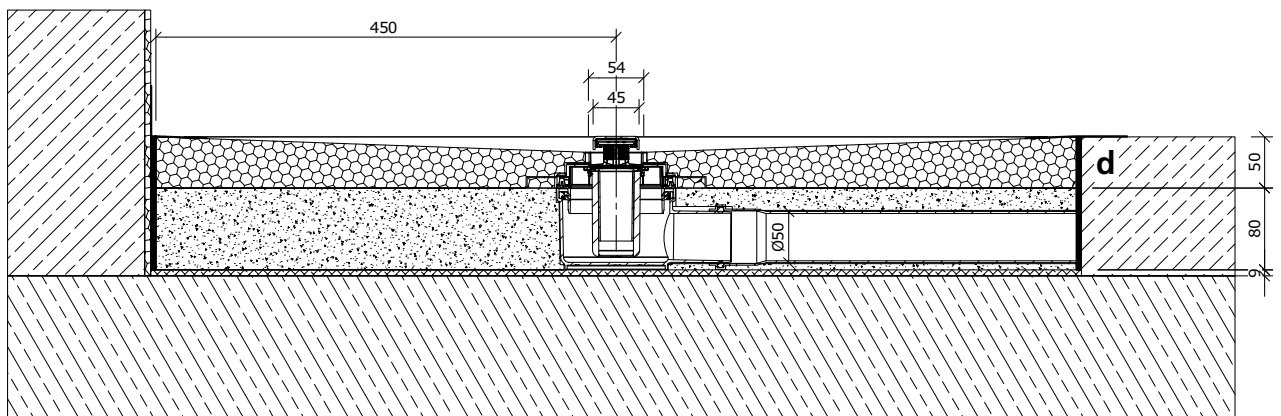

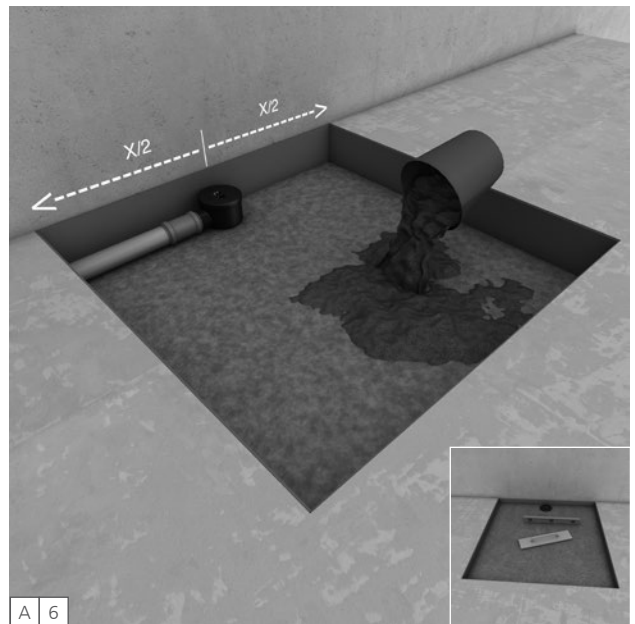
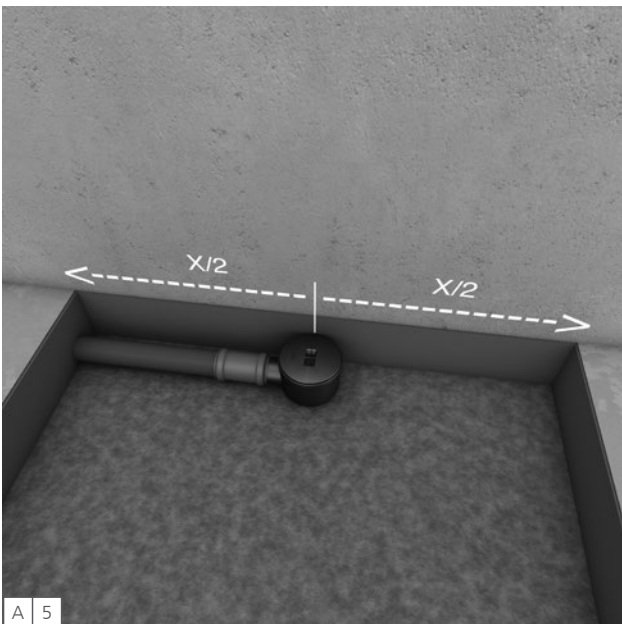
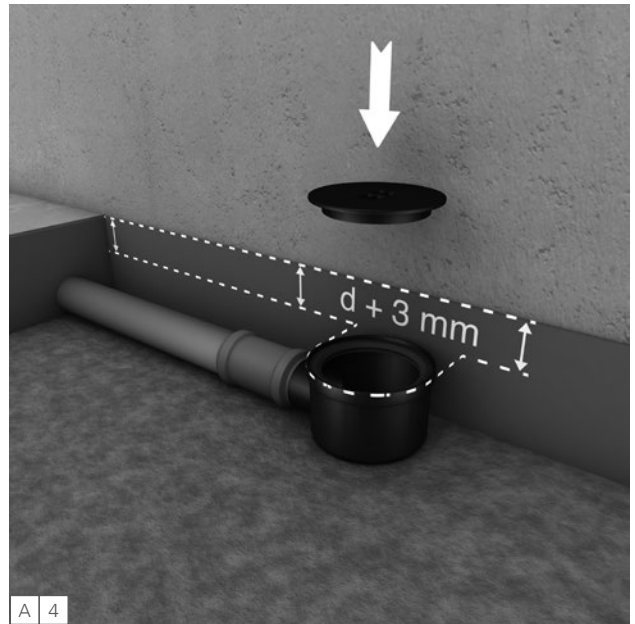
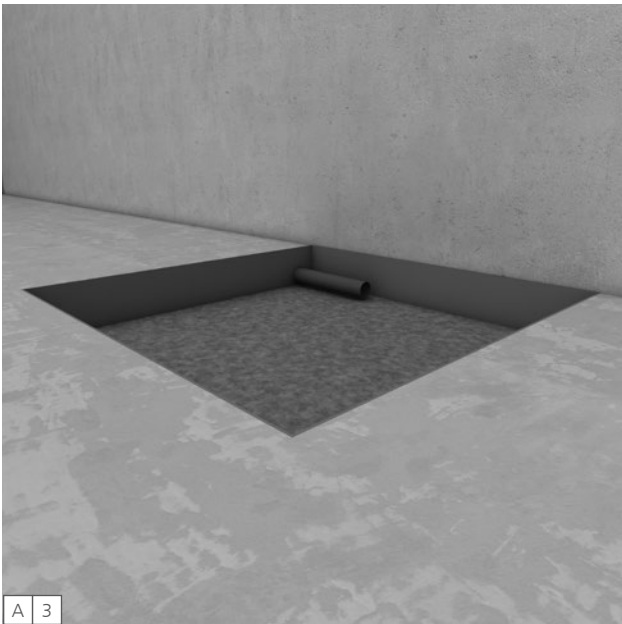
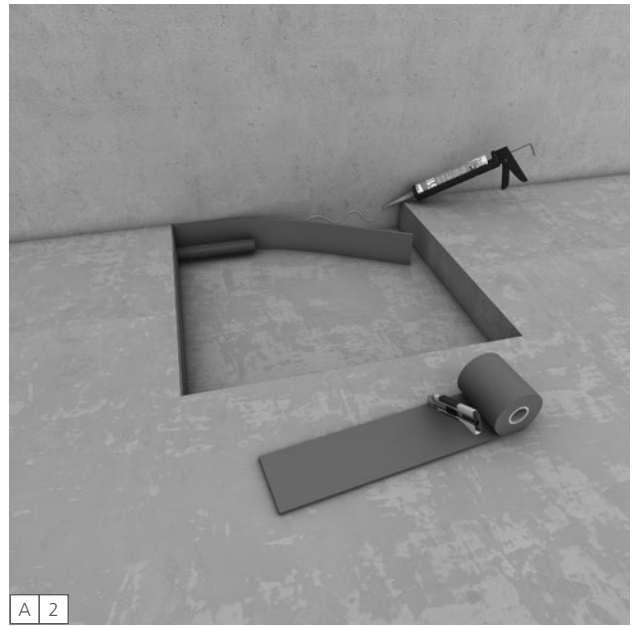
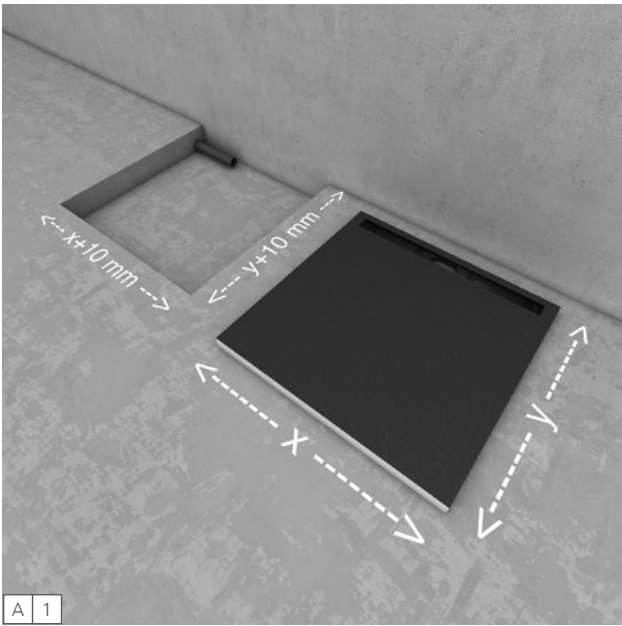

Fundo Riolito neo

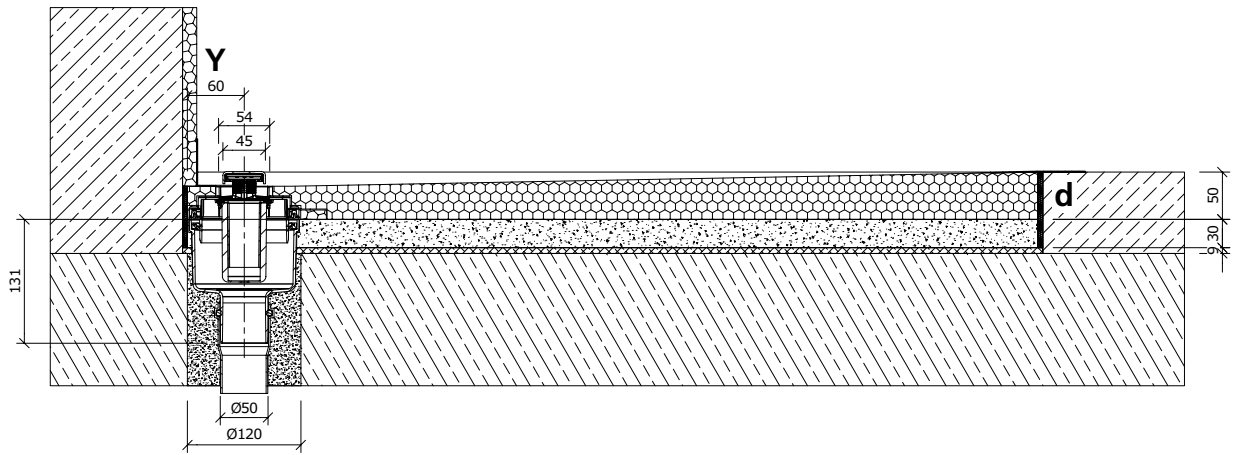

Fundo Riolito

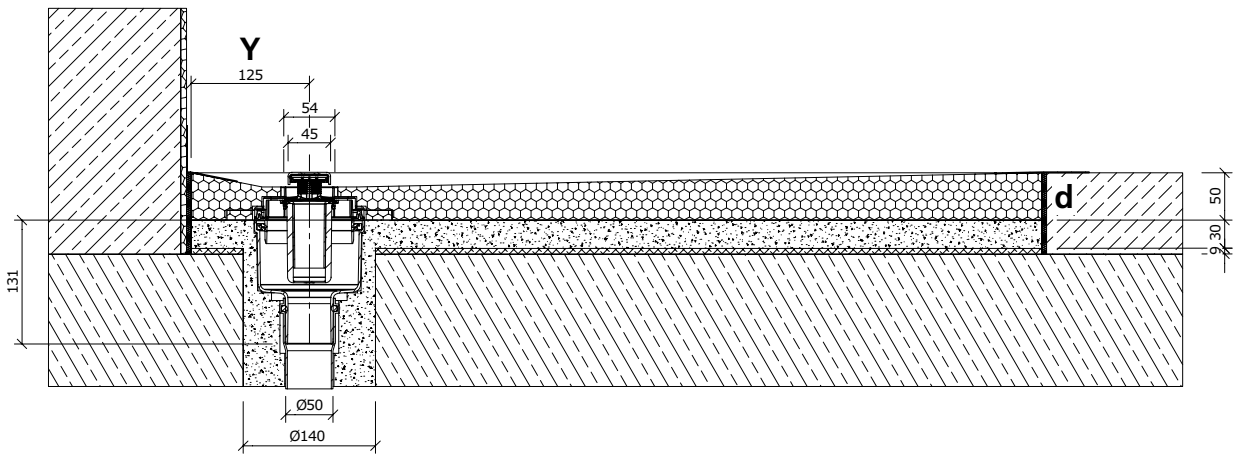

Fundo Riofino

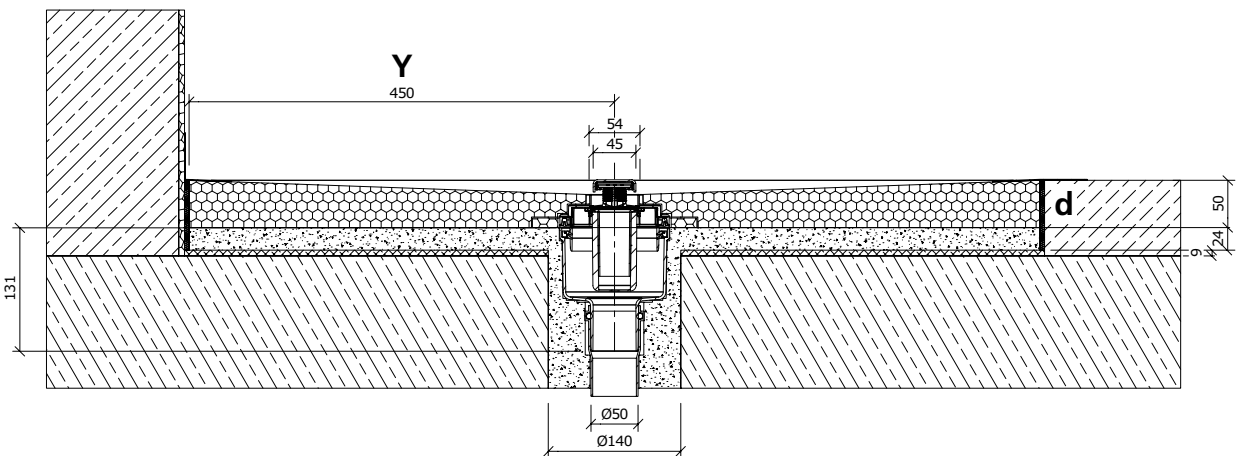

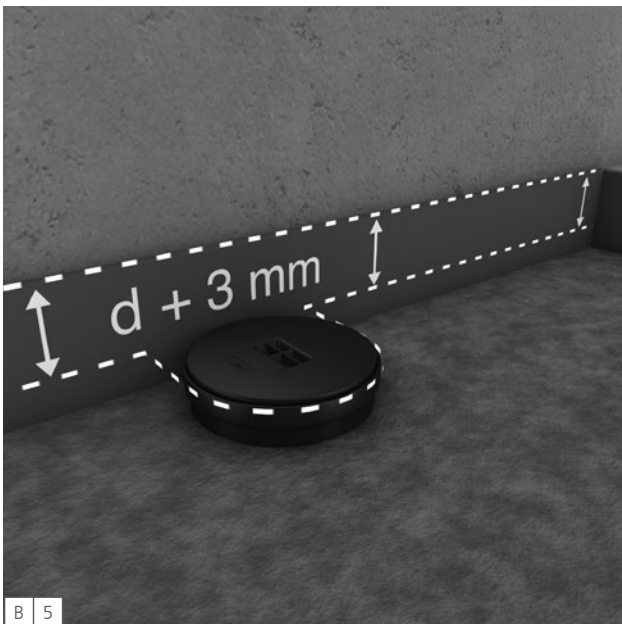
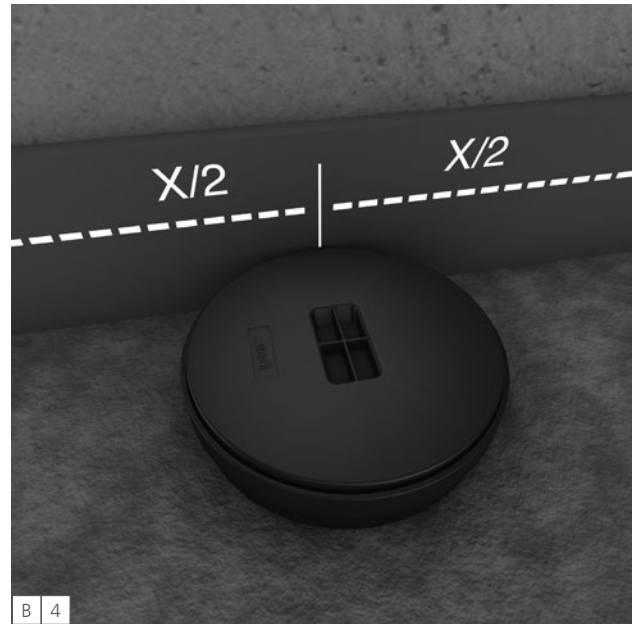
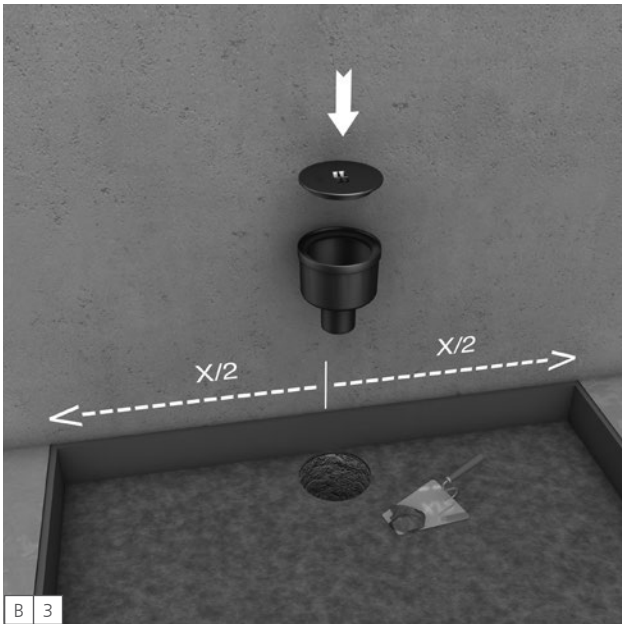
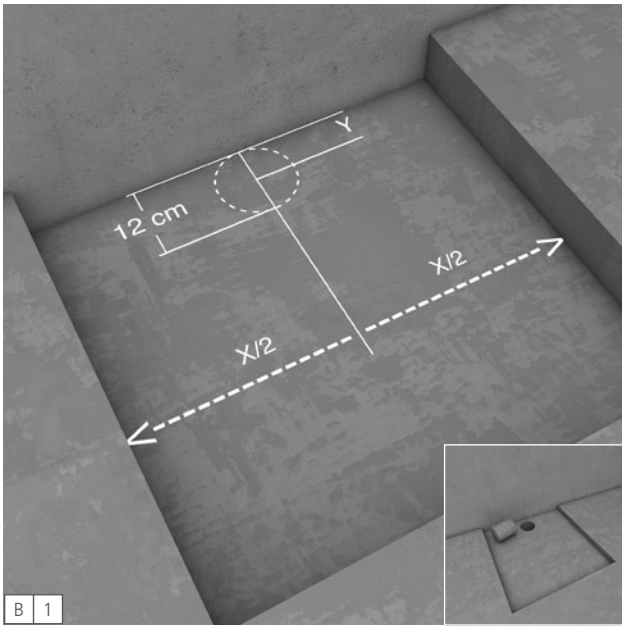

Fundo Riolito neo

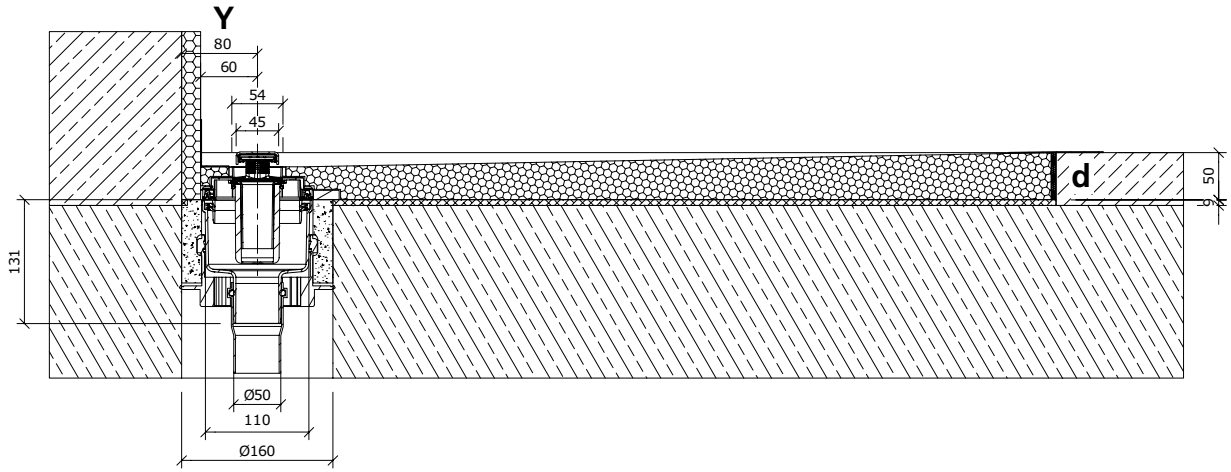

Fundo Riolito

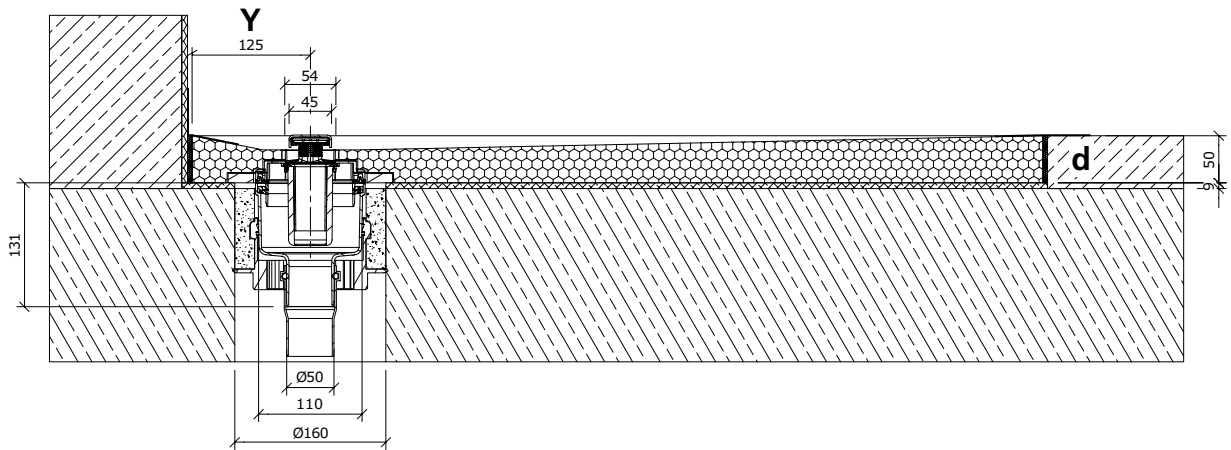

Fundo Riofino

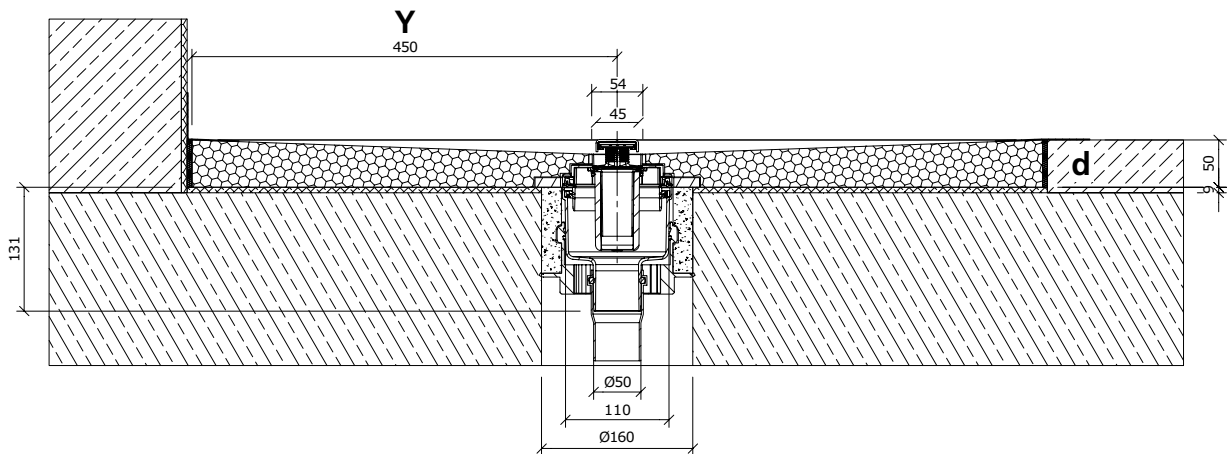

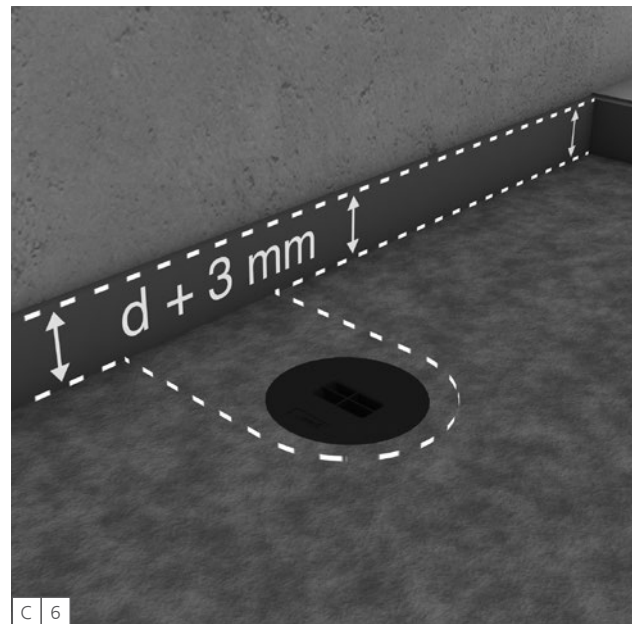
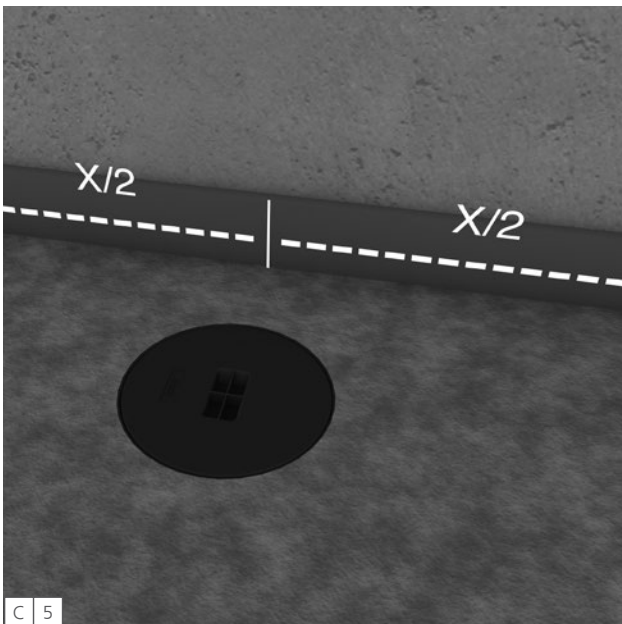
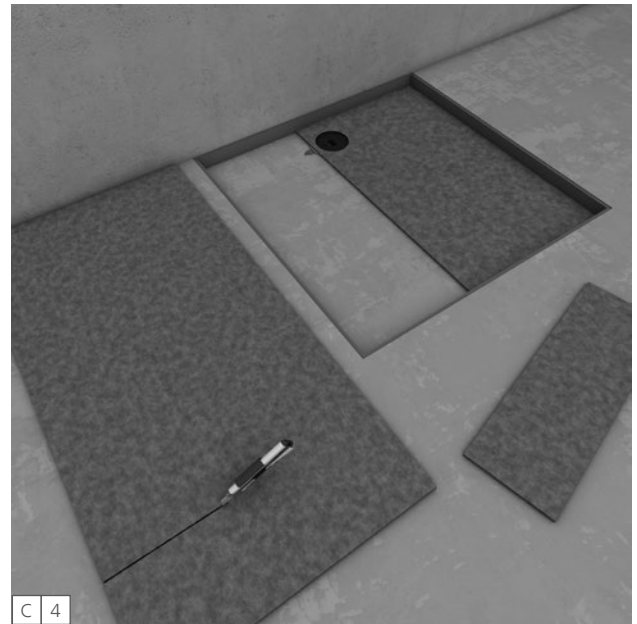
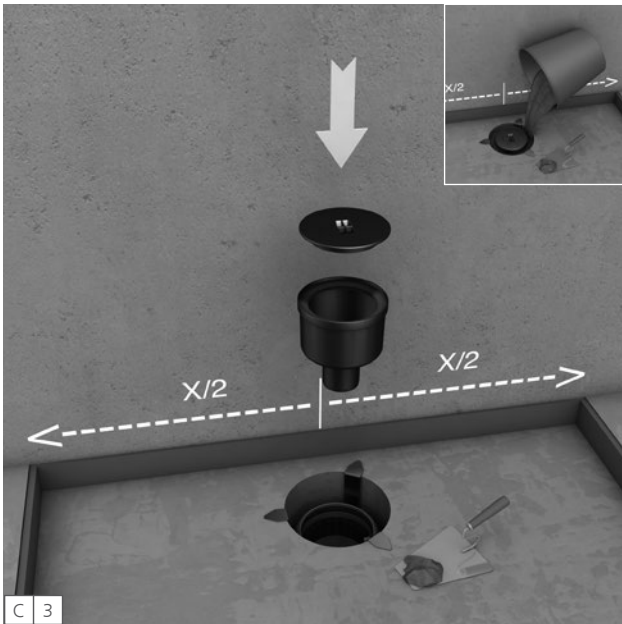
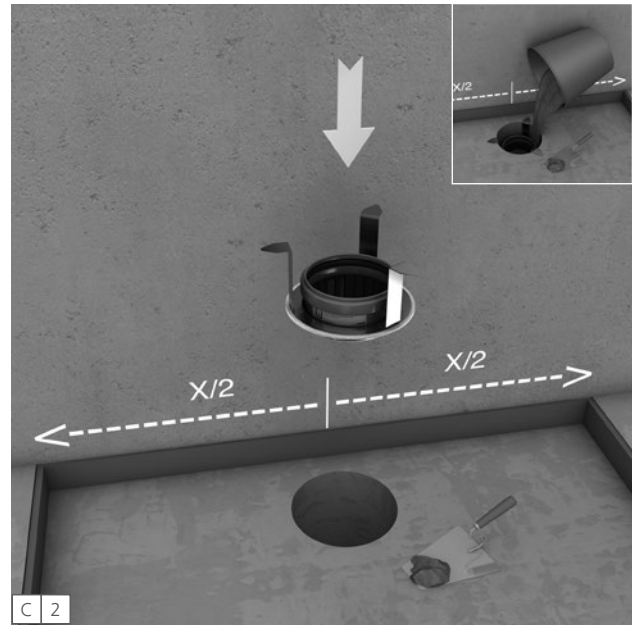
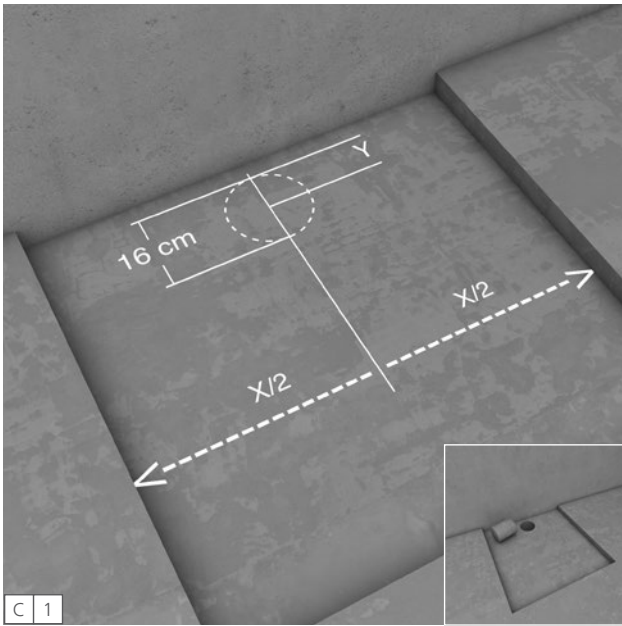

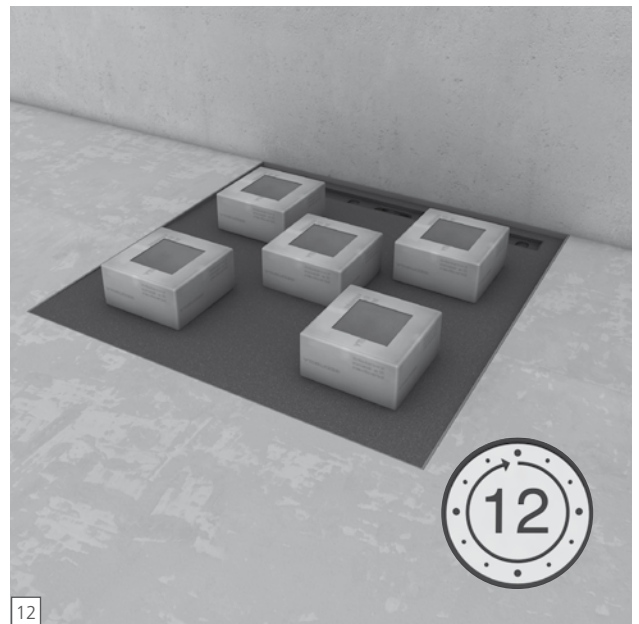
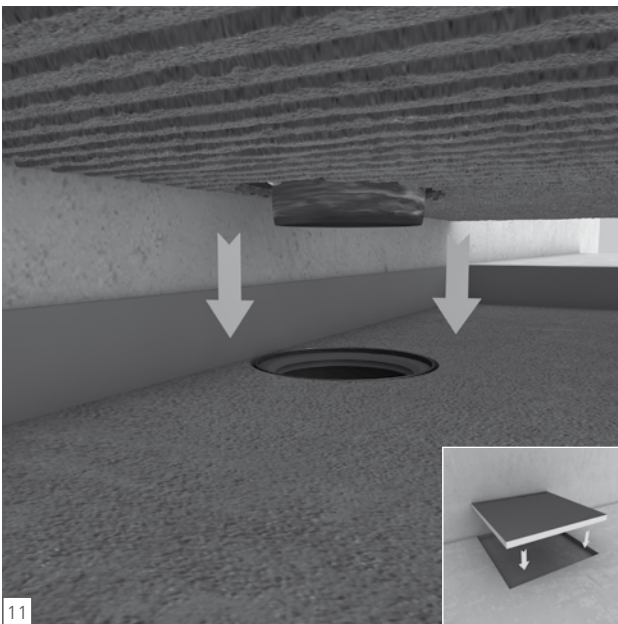
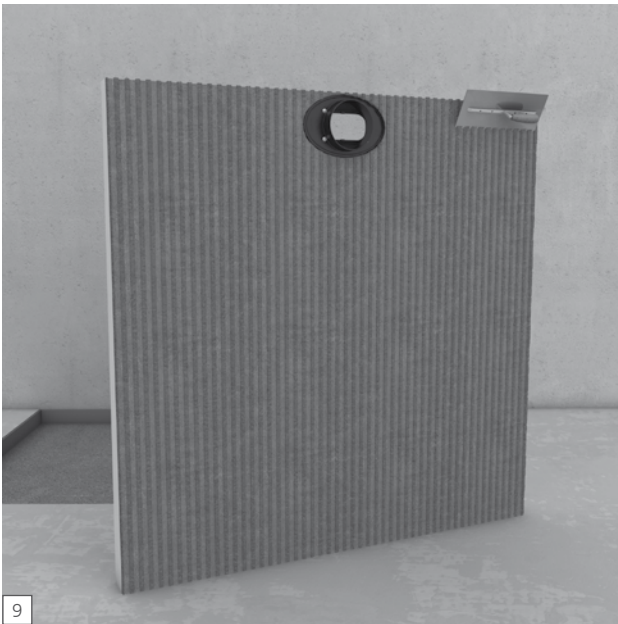
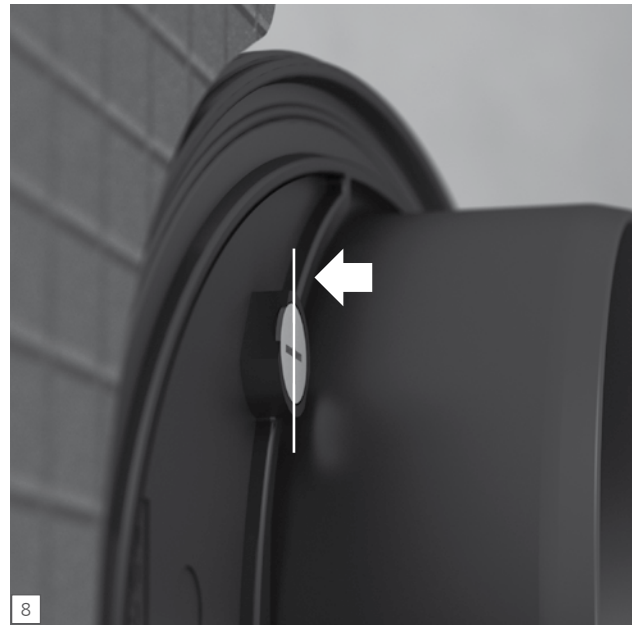
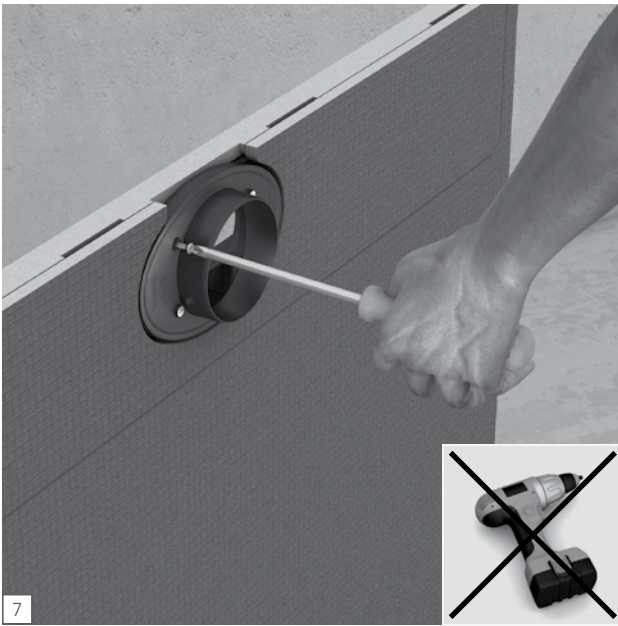

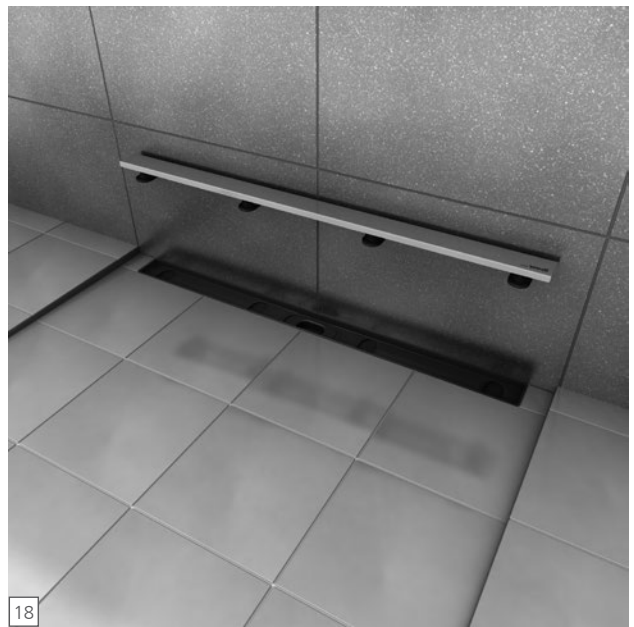
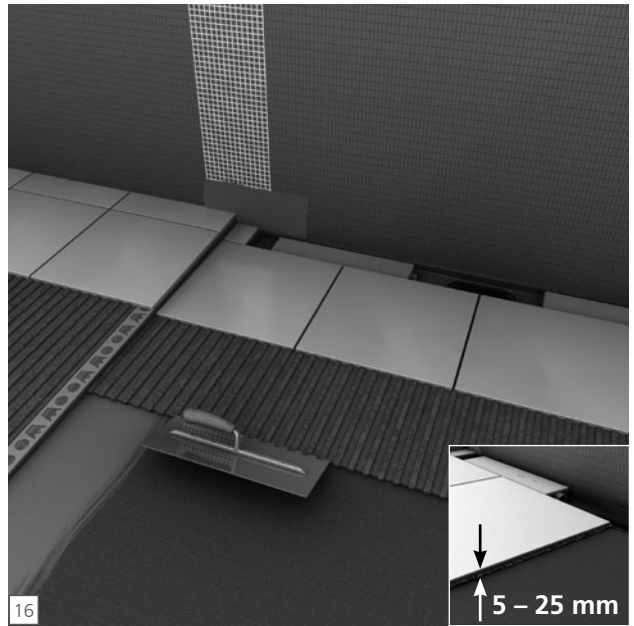
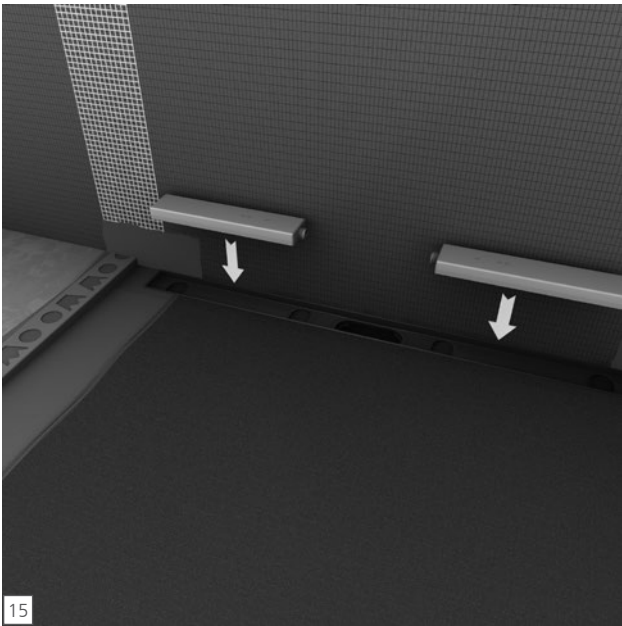
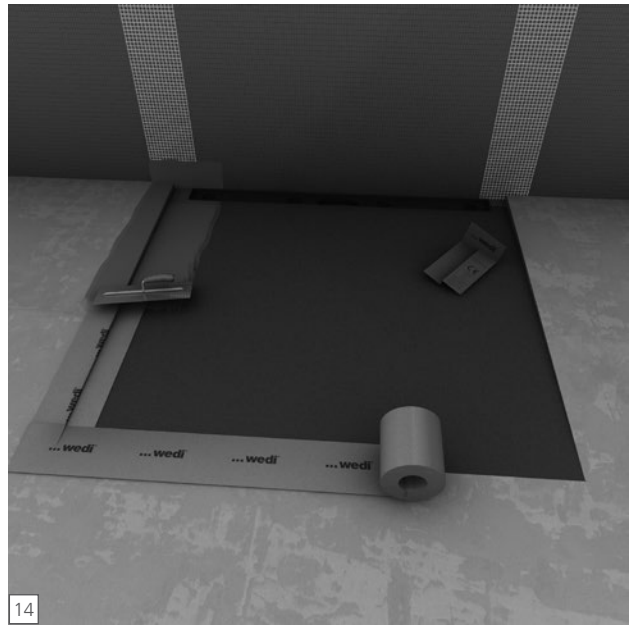
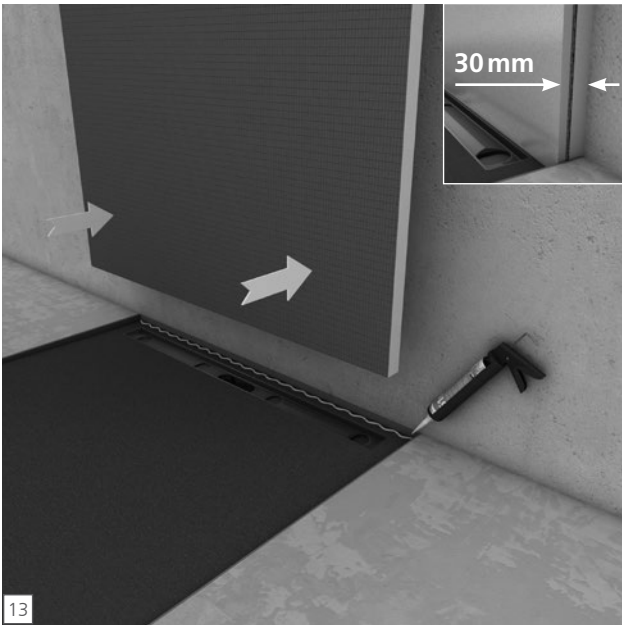

Fundo Riolito neo



Fundo Riolito



Fundo Riofino

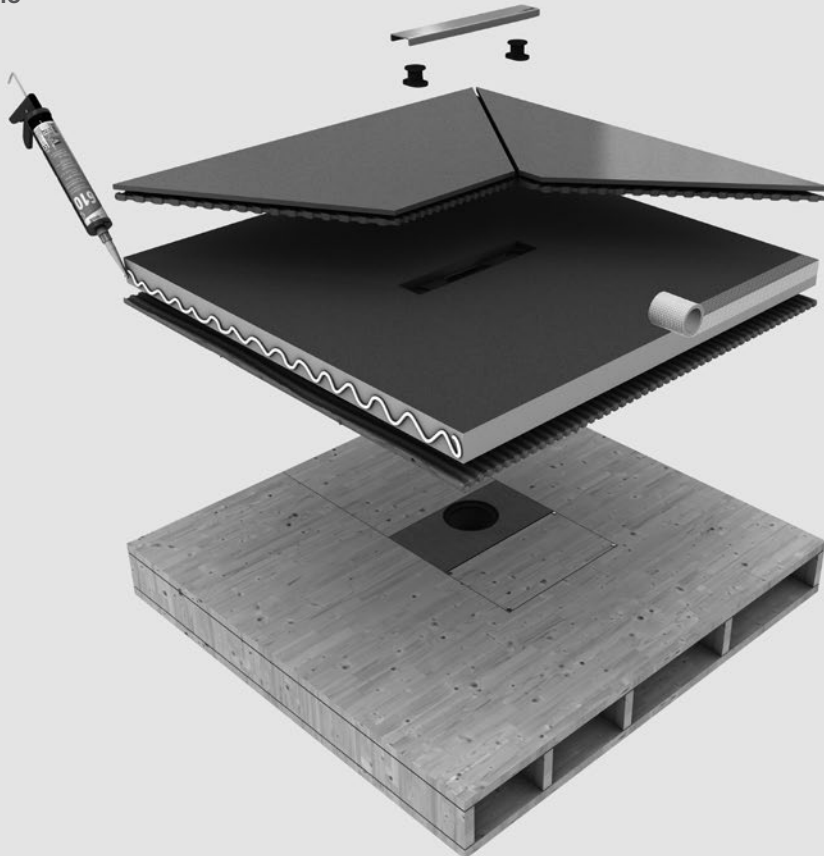

Fundo Riolito neo

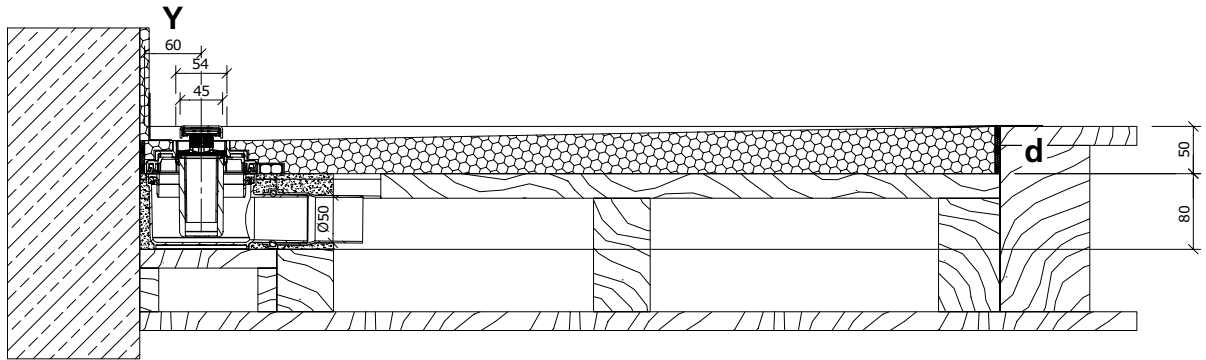

Fundo Riolito

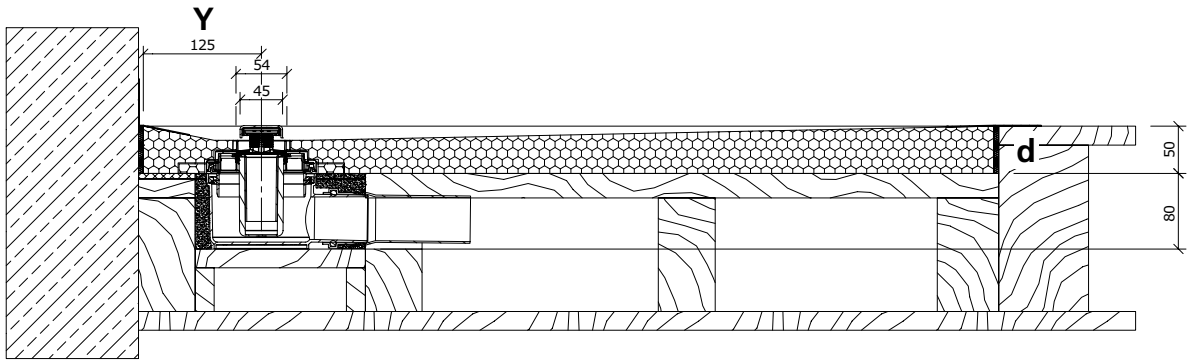

Fundo Riofino

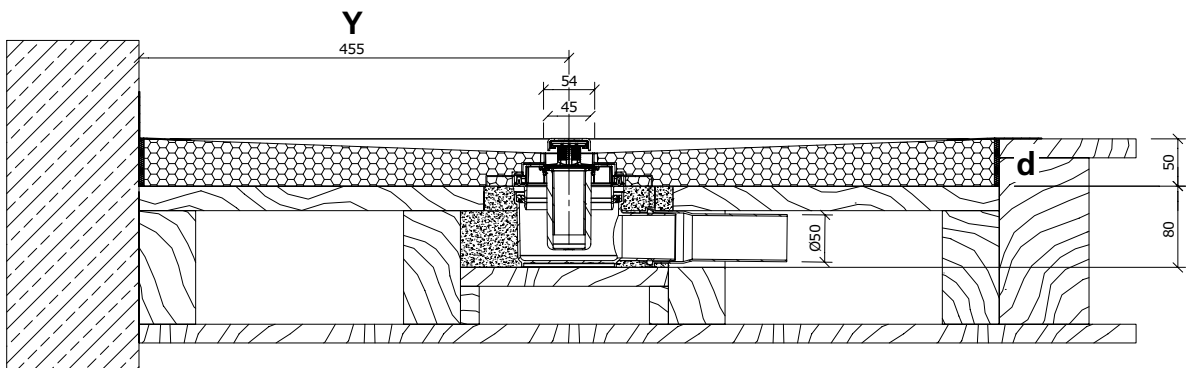

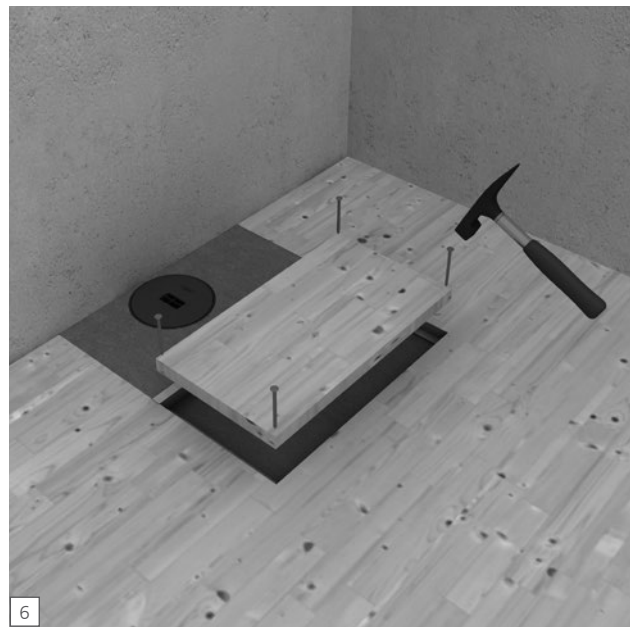
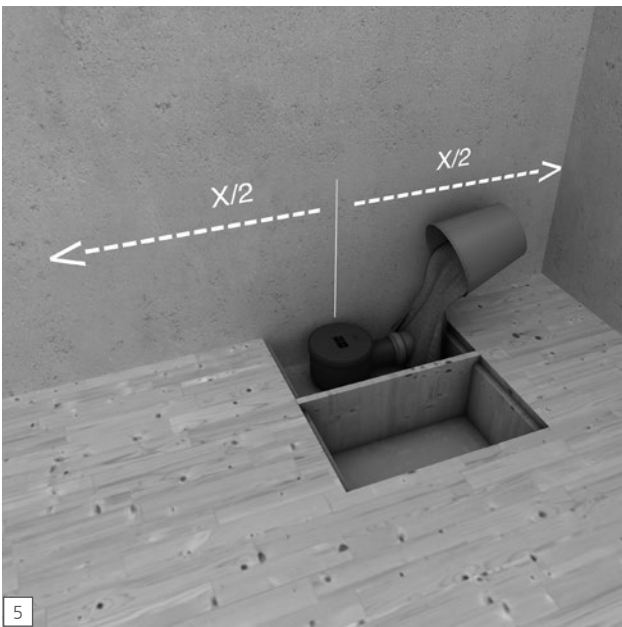
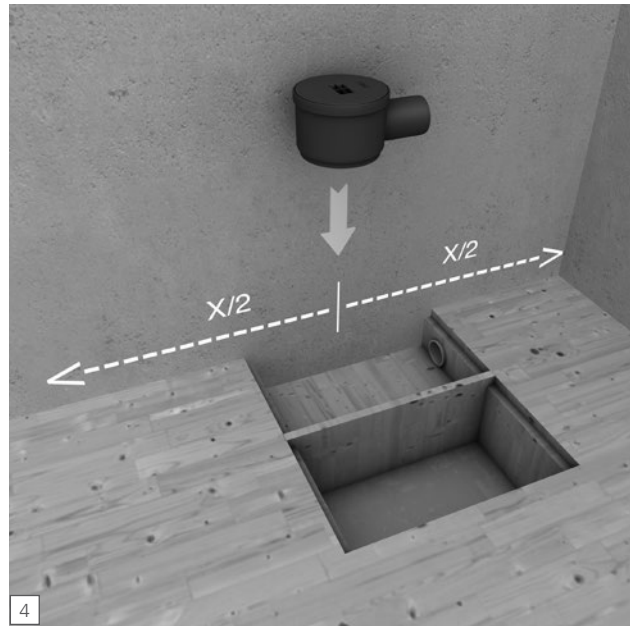
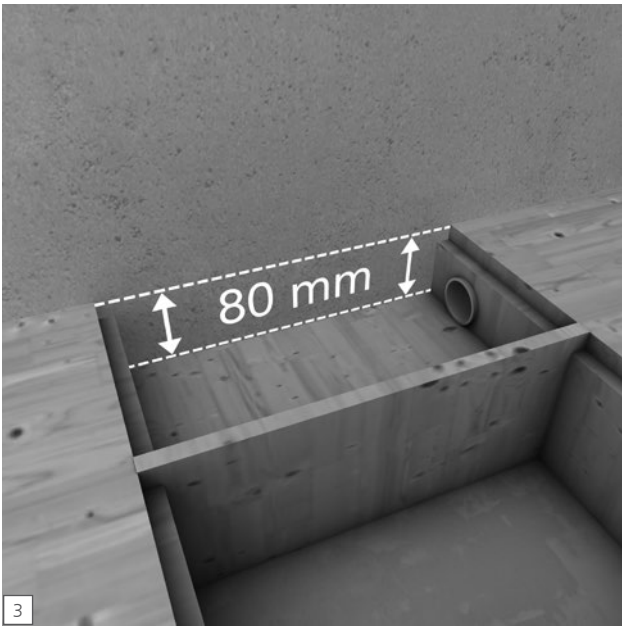
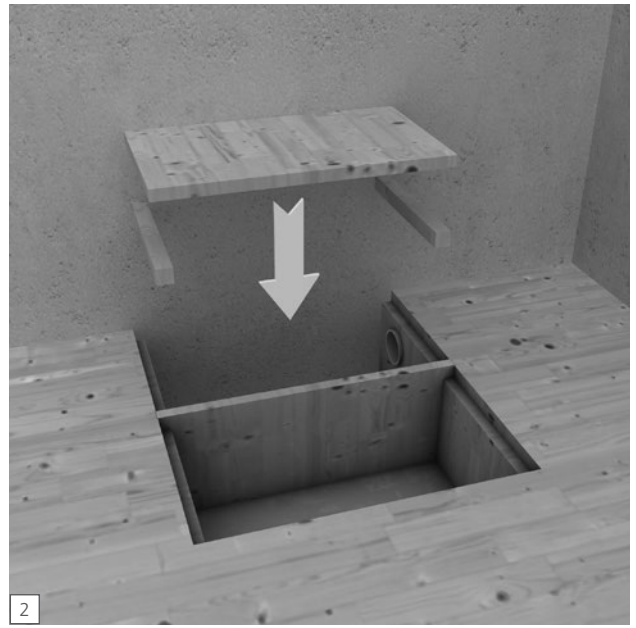
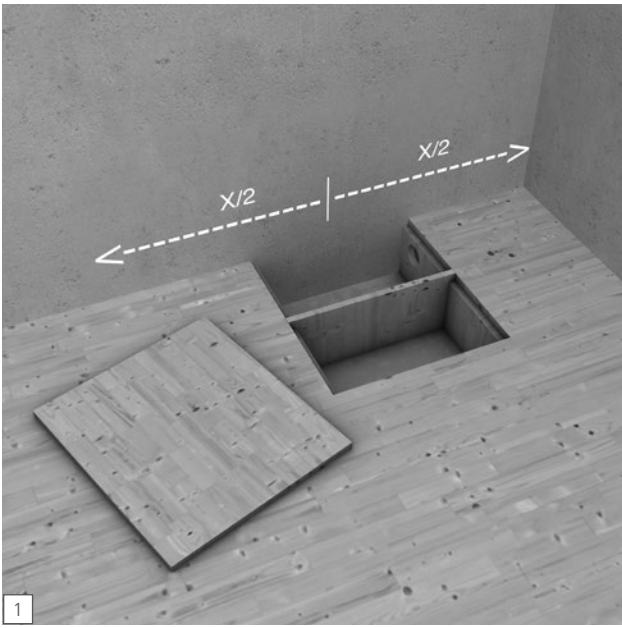

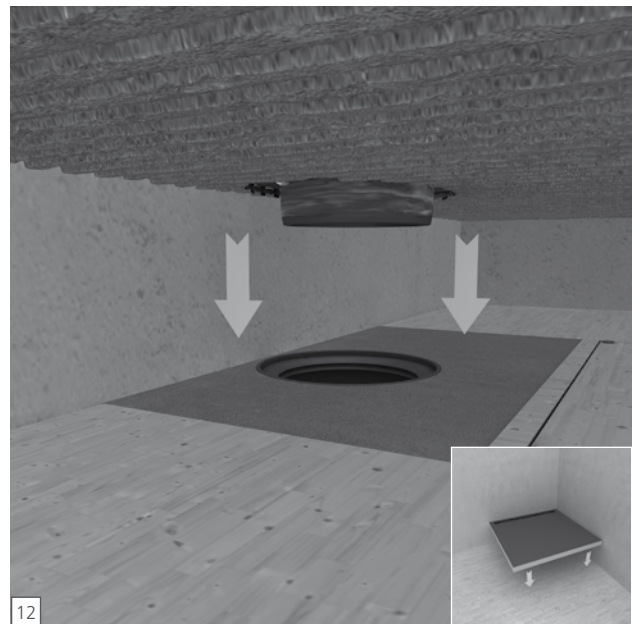
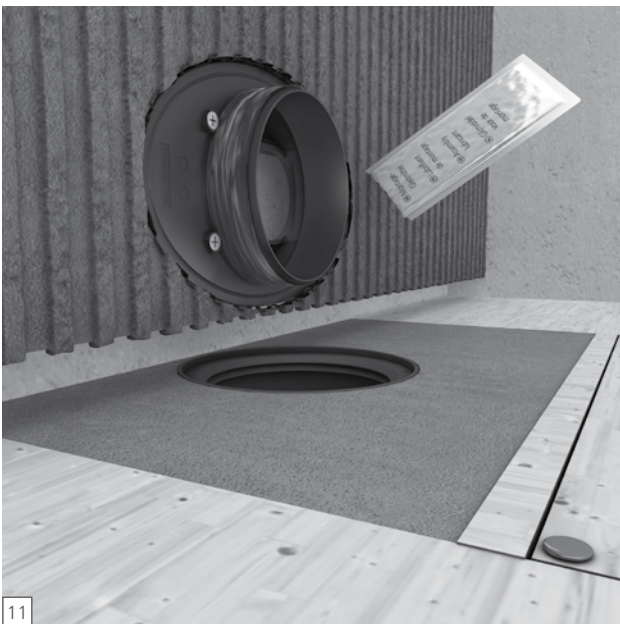
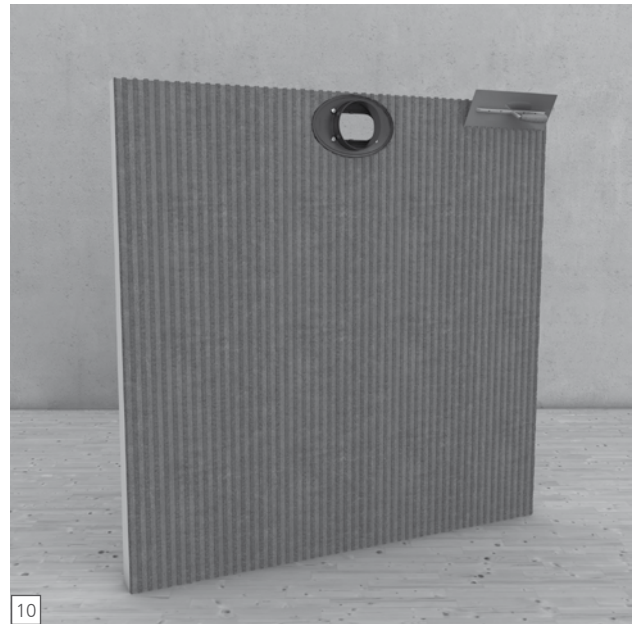
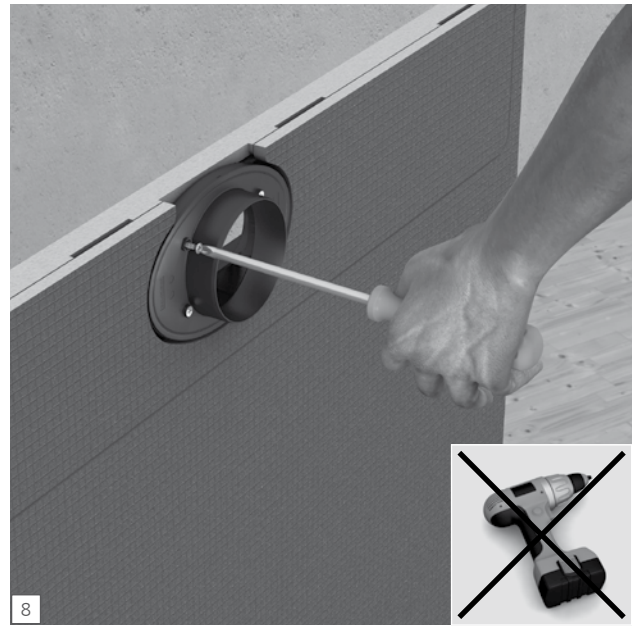
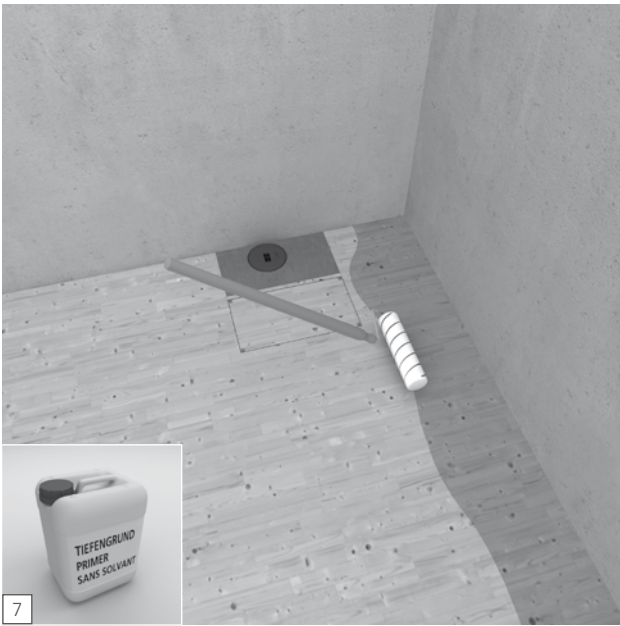

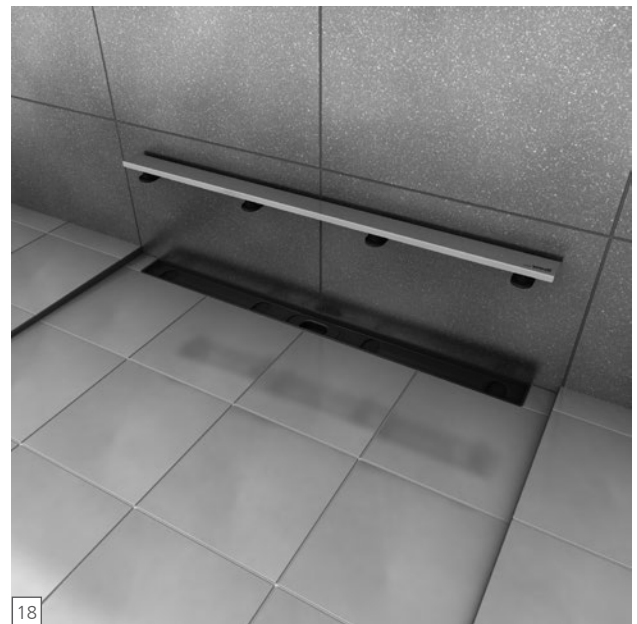
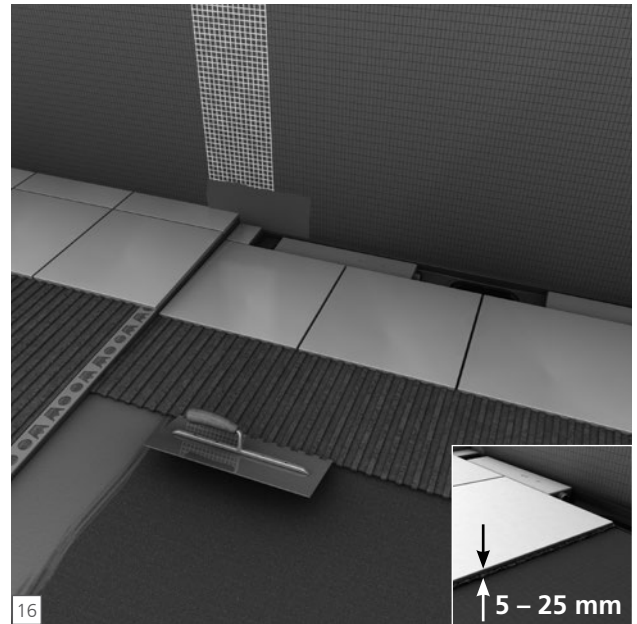
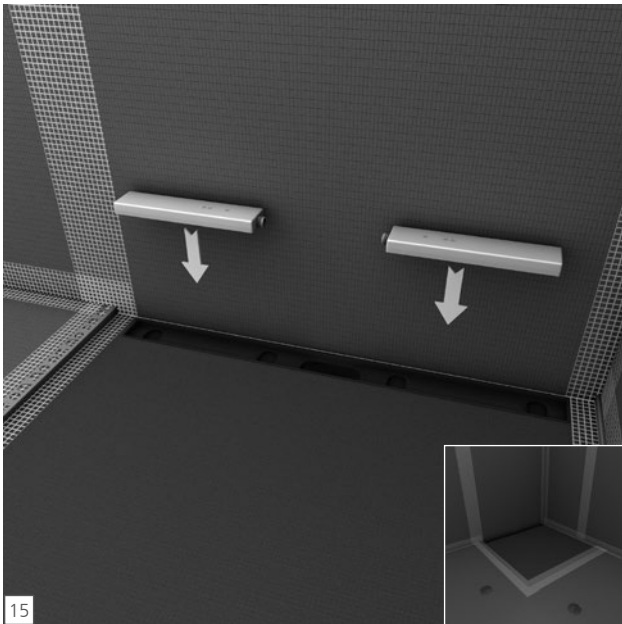
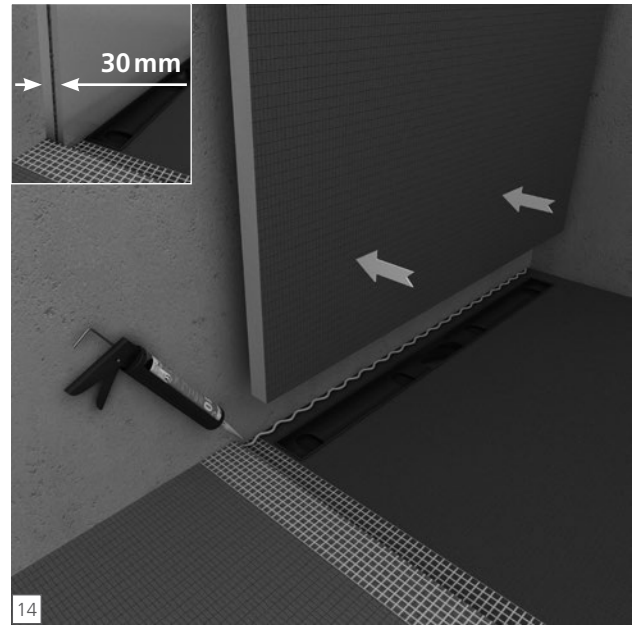
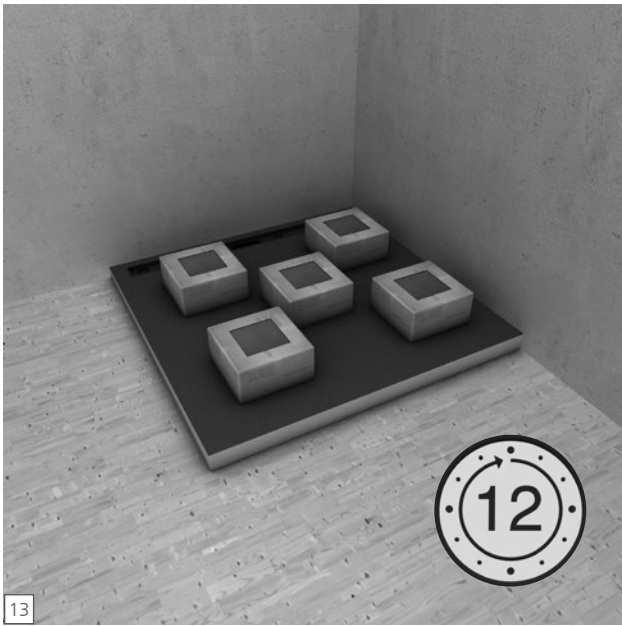



wedi GmbH

Hollefeldstraße 51
48282 Emsdetten
Deutschland

Telefon +49 2572 156-0
Telefax +49 2572 156-133

info@wedi.de
www.wedi.eu